



# Model 5202 Micro Polisher

Form # ZCE539  
Date 2-02/A



## IMPORTANT

Read these instructions carefully before installing, operating, servicing or repairing this tool. Keep these instructions in a safe accessible place.

SAFETY MESSAGES		WARNING	Operator Instructions
Personal Safety Equipment			<b>Includes:</b> <b>Safety Rules</b> <b>Foreseen Use</b> <b>Work Stations</b> <b>Putting Into Service</b> <b>Operating</b> <b>Dismantling and Assembly</b>
Use – Safety Glasses	YES		
Use – Safety Gloves	YES		
Use – Safety Boots			
Use – Breathing Masks	YES		
Use – Ear Protectors			

### Safety rules when using a 5202 Micro Polisher

- Use accessories rated at least 5,500 RPM.
- Prolonged exposure to vibration may cause injury.
- Read all instructions before using this tool. All operators must be fully trained in its use and aware of these safety rules.
- Do not exceed the maximum working air pressure.
- Use personal protection equipment as recommended.
- Some dust created by power sanding, sawing, grinding, drilling, and other construction activities contains chemicals known to cause cancer, birth defects and other reproductive harm.
- Use compressed air only at the recommended conditions.
- If the tool appears to malfunction, remove from use immediately and arrange for service and repair. If it is not practical to remove tool from service, then shut off the air supply to the tool and write or have written a warning note and attach it to the tool.
- If tool is to be used with a balancer or other suspension device, ensure that the tool is firmly attached to the suspension/support device.
- When operating the tool, always keep the body and particularly the hands away from the working attachment fixed to the tool.
- The tool is not electrically insulated. Never use the tool if there is any chance of coming into contact with live electricity.
- Always when using the tool, adopt a firm footing and/or position and grip the tool sufficiently only to overcome any reaction forces that may result from the tool doing work. Do not overgrip.
- Use only correct spare parts for maintenance and repair. Do not improvise or make temporary repairs. Major servicing and repairs should only be carried out by persons trained to do so.
- Do not lock, tape, wire, etc. the 'On/Off' valve in 'On' position. The throttle trigger/lever, etc. must always be free to return to the 'Off' position when released.
- Always shut off the air supply to the tool and press the 'On/Off' valve to exhaust the air from the feed hose before fitting, removing or adjusting the working attachment fitted to the tool.
- Before using the tool, make sure that a shut off device has been fitted to the supply line and the position is known and easily accessible so that the air supply to the tool can be shut off in an emergency.
- Check hose and fittings regularly for wear.
- Take care against entanglement of the moving parts of the tool with clothing, hair, ties, cleaning rags, rings, jewelry, watches, bracelets, etc. This could cause the body or parts of the body to be drawn towards and in contact with the moving parts of the tool and could be very dangerous.
- It is expected that users will adopt safe working practices and observe all

- local, regional or country legal requirements when installing, using or maintaining the tool.
- Take care that the exhaust air does not point towards any other person or material or substance that could be contaminated by oil droplets. When first lubricating a tool or if the tool exhaust has a high oil content, do not allow the exhaust air to come near very hot surfaces or flames.
- Never lay the tool down until the working attachment has stopped moving.
- When the tool is not in use, shut off the air supply and press throttle trigger/lever to drain the supply line. If the tool is not to be used for a period of time, first lubricate, disconnect from air supply and store in a dry average room temperature environment.
- If the tool is passed from one user to a new or inexperienced user, make sure these instructions are available to be passed with the tool.
- Do not remove any manufacturer fitted safety devices where fitted, i.e., wheel guards, safety trigger, speed governors, etc.
- Wherever possible, secure workpiece with clamps, a vise, etc. to make it rigid so it does not move during the work operation. Keep good balance at all times. Do not stretch or overreach.
- Try to match the tool to the work operation. Do not use a tool that is too light or heavy for the work operation. If in doubt, seek advice.
- In general terms, this tool is not suitable for underwater use or use in explosive environments — seek advice from manufacturer.
- Try to make sure that the work area is clear to enable the work task to be performed safely. If practical and possible, try to clear unnecessary obstructions before starting work.
- Always use air hose and couplings with minimum working pressure ratings at least 1 1/2 times the maximum working pressure rating of the tool.

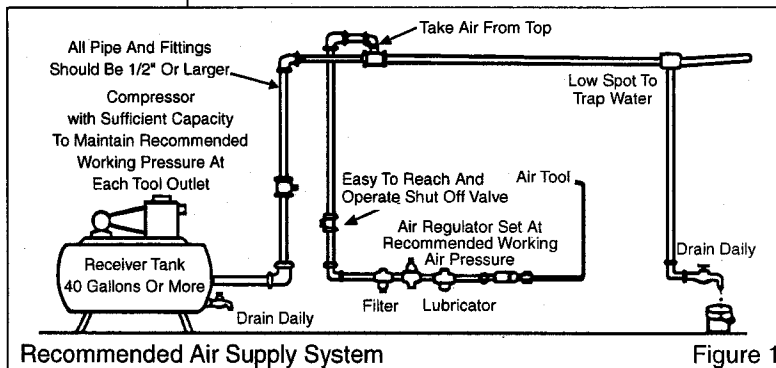

Figure 1

## Foreseen Use Of The Tool – 5202

The 5202 Micro Polisher is an ideal tool for the industrial and automotive tool room. By using a variety of accessories rated to be run at a speed of at least 5,500 rpm, the polisher can be used for surface preparation, surface cleaning, and various other specialized high speed polishing and cleaning applications. Do not use the tool, or modify the tool for any other use before first consulting the manufacturer or an authorized representative.

## Work Stations

The tool should only be used as a handheld, hand operated tool. It is always recommended that the tool is used when standing on a solid floor. It can be used in other positions, but before any such use, the operator must be in a secure position having a firm grip and footing.

## Putting Into Service

### *Air Supply*

Use a clean lubricated air supply that will give a measured air pressure at the tool of 90 p.s.i./6.2 bar when the tool is running with the trigger/lever fully depressed. Use recommended hose size and length. It is recommended that the tool is connected to the air supply as shown in figure 1. Do not connect the tool to the air line system without incorporating an easy to reach and operate air shut off valve. The air supply should be lubricated. It is strongly recommended that an air filter, regulator, lubricator (FRL) is used as shown in Figure 1 as this will supply clean, lubricated air at the correct pressure to the tool. Details of such equipment can be obtained from your supplier. If such equipment is not used, then the tool should be lubricated by shutting off the air supply to the tool, depressurizing the line by pressing the trigger/lever on the tool. Disconnect the air line and pour into the hose adaptor a teaspoonful (5ml) of a suitable pneumatic motor lubricating oil preferably incorporating a rust inhibitor. Reconnect tool to air supply and run tool slowly for a few seconds to allow air to circulate the oil. If tool is used frequently, lubricate on daily basis and if tool starts to slow or lose power.

It is recommended that the air pressure at the tool while the tool is running is 90 psi/6.2 bar.

## Operating

Select a suitable polishing accessory rated to run at least 5,500 rpm and attach securely to spindle (4).

The trigger (20) is the on/off valve for the tool. The air flow can be controlled by the adjustment of regulator (16) situated at the rear of the tool.

Turn regulator (16) until the raised band is in line with the axis of the pistol grip handle for maximum rpm and turn through 90° for minimum rpm.

When making speed checks always make sure that the regulator is in the high speed/power position.

An air strainer is located in inlet bushing (29) and this should be checked periodically for blockage particularly if the tool slows or loses power. Remove inlet bushing (29) from motor housing (18) to clean the strainer.

## Dismantling & Assembly Instructions

Disconnect tool from air supply.

Place the motor housing (18) in a vise fitted with soft jaws with the handle section pointing upwards, unscrew inlet bushing (29) with screen and take off deflector (28), O-ring (27), valve spring (26), valve (25) with valve pin (24) assembly and muffler (22). Push out valve pin (24) from valve (25) when needed. Drive out roll pin (19) from motor housing (18) then grip trigger (20) and pull out the valve shaft (21). Unscrew clamp nut (1), then spindle nut (2), ball bearing (3), spindle (4) assembly, idler gear (5) and pinion gear (6) can pull out easily. Remove internal gear (7) and spacer (8) from motor housing (18). Pull out the motor assembly, regulator (16) and O-ring (17), then grip front plate (10) by hand and tap the splined end of the rotor (11) with a non-metallic or soft metal (lead or aluminum) hammer to drive the rotor through the components being held. Take out 4 rotor blades (12) from rotor (11) and take off cylinder (13). Support the rear plate (15) in a piece of tube with a bore diameter as close as possible to the maximum diameter of the rotor and tap the non-splined end of the rotor to drive the rotor through the rear plate (15) and bearing (9). To remove front plate (10) with ball bearing (9) assembly from rotor (11), grip the front plate (10) by hand or another way, tap the splined end of the rotor.





### *Reassembly*

Clean all components and examine for wear. Look in particular for wear and cuts on O-rings, wear on rotor blades, gear and clutch components. Coat all parts with a suitable pneumatic lubricating oil and grease all bearings, gears, and clutch parts with a molybdenum or lithium based general purpose grease. Before reassembling the motor, make sure that the faces of end plates (10, 15) that abut cylinder (13) are flat and free from burrs. If necessary, lap on a flat very fine grade of abrasive paper. Reassemble in the reverse order. When refitting the complete motor assembly to the housing (18) first, make sure that the assembly is clamped tightly together and the rotor spins freely.

Operation Specification	
Air Consumption	3.5 cfm (25 scfm)
Air Inlet Thread	1/4-18NPT
Overall Length	4.6" (118 mm)
at 90 PSIG/6.2 bar	

NOTES

NOTES

<b>Manufacturer/Supplier</b>  <b>Sioux Tools, Inc.</b> <b>117 Levi Drive</b> <b>Murphy, NC 28906</b> <b>U.S.A.</b> <b>Tel No. 828-835-9765      Fax No. 828-835-9685</b>		<b>Product Type</b>  <b>Micro Polisher</b>	RPM <b>5,500</b> Cycles Per Min.	
		<b>Model No/Nos</b>  <b>5202</b>	Serial No.	
<b>Product Net Weight</b> 1.60 lbs 0.72 Kg	<b>Recommended Use Of Balancer Or Support</b>  <b>NO</b>	<b>Recommended Hose Bore Size – Minimum</b> <b>5/16 Ins    8 mm</b>	<b>Recommended Max. Hose Length</b> <b>30 Ft    10 M</b>	
<b>Air Pressure</b>  <b>Recommended Working    6.2 bar    90 PSI</b> <b>Maximum                      6.2 bar    90 PSI</b>		<b>Noise Level: Sound Pressure Level 82.0 dB(A)</b>  <b>Test Method: Tested in accordance with Pneurop test code PN8NTC1 and ISO Standard 3744</b>		
<b>SAFETY MESSAGES</b> Personal Safety Equipment Use – Safety Glasses <b>YES</b> Use – Safety Gloves <b>YES</b> Use – Safety Boots Use – Breathing Masks <b>YES</b> Use – Ear Protectors	<b>WARNING</b>  Always Read Instructions Before Using Power Tools  Always Wear Safety Goggles  Wear Hearing Protection  Avoid Prolonged Exposure To Vibration		<b>Vibration Level</b>  <b>3.7 Meters / Sec<sup>2</sup></b>	<b>Test Method: Tested in accordance with ISO standards 8662/1</b>

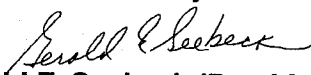
  
**Declaration of Conformity**  
**Sioux Tools Inc.**  
**117 Levi Drive, Murphy, NC 28906, U.S.A.**  
declare under our sole responsibility that the product  
**Model 5202 Micro Polisher, Serial Number**  
to which this declaration relates is in conformity with the following standard(s) or other normative document(s)  
**EN792 (Draft), EN292 Parts 1 & 2, ISO 8662 Part 1, Pneurop PN8NTC1**  
following the provisions of **89/392/EEC as amended by 91/368/EEC & 93/44/EEC Directives**  
  
  
**Gerald E. Seebeck (President)**

-----  
Name and signature or equivalent marking of authorized person



# 5202 Micro Polisher

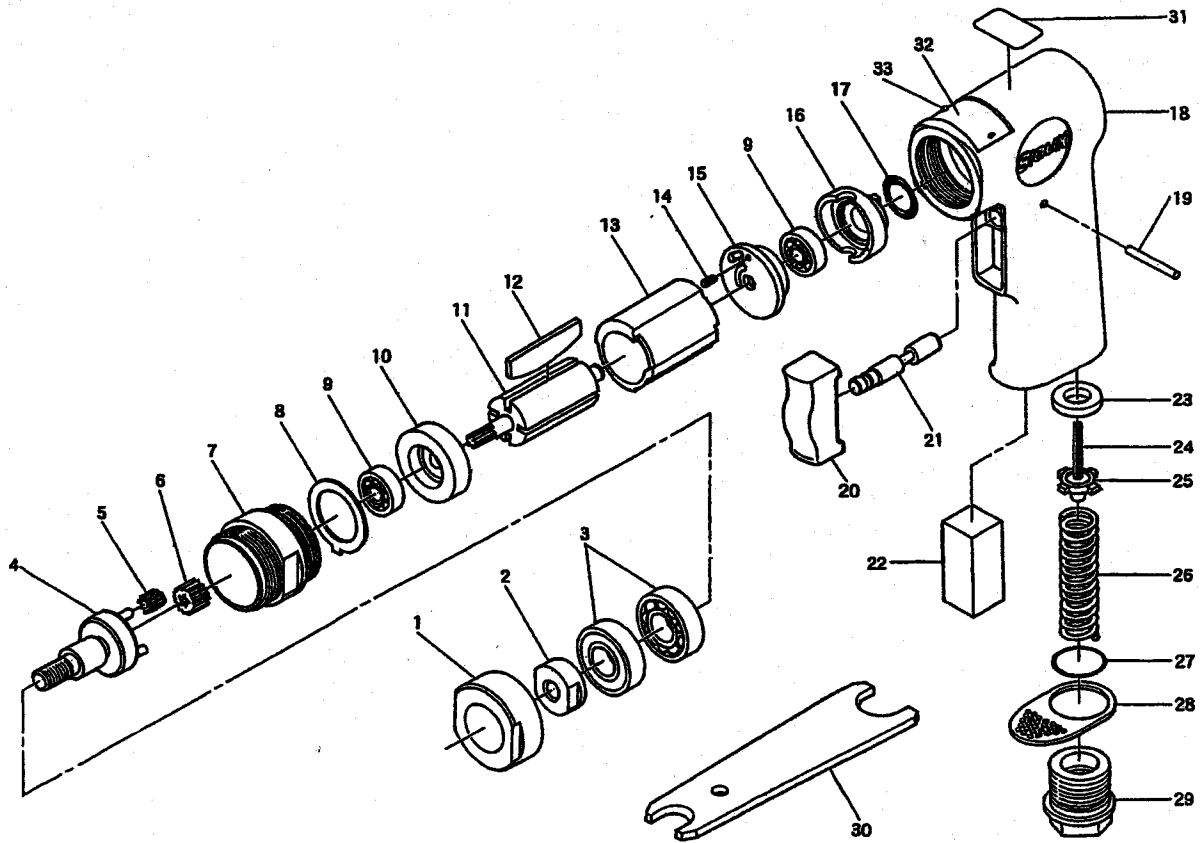

Ref. No.	Part No.	Description
1	505736	Clamp Nut
2	505737	Spindle Nut
3	67328	Ball Bearing (2)*
4	505738	Spindle including Pin x 3
5	505739	Idler Gear (3)*
6	505740	Pinion Gear
7	505767	Internal Gear
8	505722	Spacer
9	66504	Ball Bearing (2)*
10	505741	Front Plate
11	505768	Rotor
12	66507	Rotor Blade (Set of 4)
13	66509	Cylinder
14	66502	Roll Pin
15	505717	Rear Plate
16	505716	Regulator
17	67081	O-Ring

Ref. No.	Part No.	Description
18	505742	Motor Housing
19	505713	Roll Pin
20	505715	Trigger
21	505714	Valve Shaft
22	505711	Muffer
23	505365	Valve Seat
24	505366	Valve Pin
25	505367	Valve
26	505710	Valve Spring
27	505371	O-Ring
28	505709	Deflector
29	505732	Inlet Bushing with screen
30	505725	Spanner Wrench
31	505001	Warning Label
32	505743	Name Plate
33	67255	Name Plate Screw (2)*
	515	3" Velcro Pad (Not Shown)

\* Order Quantity As Needed

This pdf incorporates the following model numbers:  
5202