



Model 5201 Micro D/A Sander

Form # Z538
Date 2-99/A



IMPORTANT

Read these instructions carefully before installing, operating, servicing or repairing this tool. Keep these instructions in a safe accessible place.

SAFETY MESSAGES		WARNING	Operator Instructions
Personal Safety Equipment			
Use – Safety Glasses	YES	Always Read Instructions Before Using Power Tools	Includes: Safety Rules Foreseen Use Work Stations Putting Into Service Operating Dismantling and Assembly.
Use – Safety Gloves	YES	Always Wear Safety Goggles	
Use – Safety Boots		Wear Hearing Protection	
Use – Breathing Masks	YES	Avoid Prolonged Exposure To Vibration	
Use – Ear Protectors			

Safety rules when using a 5201 Micro D/A Sander

- Use accessories rated at least 15,000 RPM.
- Prolonged exposure to vibration may cause injury.
- Read all instructions before using this tool. All operators must be fully trained in its use and aware of these safety rules.
- Do not exceed the maximum working air pressure.
- Use personal protection equipment as recommended.
- Use compressed air only at the recommended conditions.
- If the tool appears to malfunction, remove from use immediately and arrange for service and repair. If it is not practical to remove tool from service, then shut off the air supply to the tool and write or have written a warning note and attach it to the tool.
- If tool is to be used with a balancer or other suspension device, ensure that the tool is firmly attached to the suspension/support device.
- When operating the tool, always keep the body and particularly the hands away from the working attachment fixed to the tool.
- The tool is not electrically insulated. Never use the tool if there is any chance of coming into contact with live electricity.
- Always when using the tool, adopt a firm footing and/or position and grip the tool sufficiently only to overcome any reaction forces that may result from the tool doing work. Do not overgrip.
- Use only correct spare parts for maintenance and repair. Do not improvise or make temporary repairs. Major servicing and repairs should only be carried out by persons trained to do so.
- Do not lock, tape, wire, etc. the 'On/Off' valve in 'On' position. The throttle trigger/ lever, etc. must always be free to return to the 'Off' position when released.
- Always shut off the air supply to the tool and press the 'On/Off' valve to exhaust the air from the feed hose before fitting, removing or adjusting the working attachment fitted to the tool.
- Before using the tool, make sure that a shut off device has been fitted to the supply line and the position is known and easily accessible so that the air supply to the tool can be shut off in an emergency.
- Check hose and fittings regularly for wear.
- Take care against entanglement of the moving parts of the tool with clothing, hair, ties, cleaning rags, rings, jewelry, watches, bracelets, etc. This could cause the body or parts of the body to be drawn towards and in contact with the moving parts of the tool and could be very dangerous.
- It is expected that users will adopt safe working practices and observe all local, regional or country legal requirements when installing, using or maintaining the tool.
- Take care that the exhaust air does not point towards any other person or material or substance that could be contaminated by oil droplets. When first lubricating a tool or if the tool exhaust has a high oil content, do not allow the exhaust air to come near very hot surfaces or flames.
- Never lay the tool down until the working attachment has stopped moving.
- When the tool is not in use, shut off the air supply and press throttle trigger/lever to drain the supply line. If the tool is not to be used for a period of time, first lubricate, disconnect from air supply and store in a dry average room temperature environment.
- If the tool is passed from one user to a new or inexperienced user, make sure these instructions are available to be passed with the tool.
- Do not remove any manufacturer fitted safety devices where fitted, i.e., wheel guards, safety trigger, speed governors, etc.
- Wherever possible, secure workpiece with clamps, a vise,

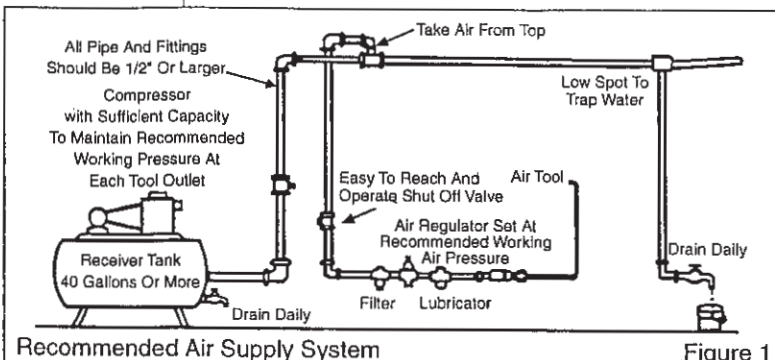

- etc. to make it rigid so it does not move during the work operation. Keep good balance at all times. Do not stretch or overreach.
- Try to match the tool to the work operation. Do not use a tool that is too light or heavy for the work operation. If in doubt, seek advice.
 - In general terms, this tool is not suitable for underwater use or use in explosive environments — seek advice from

manufacturer.

- Try to make sure that the work area is clear to enable the work task to be performed safely. If practical and possible, try to clear unnecessary obstructions before starting work.
- Always use air hose and couplings with minimum working pressure ratings at least 1 1/2 times the maximum working pressure rating of the tool.

Foreseen Use Of The Tool – 5201

The 5201 Micro D/A Sander is an ideal tool for the industrial and automotive tool room. By using a variety of accessories rated to be run at a speed of at least 15,000 rpm, the sander can be used for surface preparation, surface cleaning, removing gasket residue and various other specialized high speed polishing and cleaning applications. Do not use the tool, or modify the tool for any other use before first consulting the manufacturer or an authorized representative.

Work Stations

The tool should only be used as a handheld, hand operated tool. It is always recommended that the tool is used when standing on a solid floor. It can be used in other positions, but before any such use, the operator must be in a secure position having a firm grip and footing.

Putting Into Service

Air Supply

Use a clean lubricated air supply that will give a measured air pressure at the tool of 90 p.s.i./6.2 bar when the tool is running with the trigger/lever fully depressed. Use recommended hose size and length. It is recommended that the tool is connected to the air supply as shown in figure 1. Do not connect the tool to the air line system without incorporating an easy to reach and operate air shut off valve. The air supply should be lubricated. It is strongly recommended that an air filter, regulator, lubricator (FRL) is used as shown in Figure 1 as this will supply clean, lubricated air at the correct pressure to the tool. Details of such equipment can be obtained from your supplier. If such equipment is not used, then the tool should be lubricated by shutting off the air supply to the tool, depressurizing the line by pressing the trigger/lever on the tool. Disconnect the air line and pour into the hose adaptor a teaspoonful (5ml) of a suitable pneumatic motor lubricating oil preferably incorporating a rust inhibitor. Reconnect tool to air supply and run tool slowly for a few seconds to allow air to circulate the oil. If tool is used frequently, lubricate on daily basis and if tool starts to slow or lose power.

It is recommended that the air pressure at the tool while the tool is running is 90 psi/6.2 bar.

Operating

Select a suitable abrasive device rated to run at least 15,000 rpm and attach securely to the random shaft assembly (28).

The trigger (12) is the on/off valve for the tool. The air flow can be controlled by the adjustment of regulator (14) situated at the rear of the tool.

Turn regulator (14) until the raised band is in line with the axis of the pistol grip handle for maximum rpm and turn through 90° for minimum rpm.

When making speed checks always make sure that the regulator is in the high speed/power position.

An air strainer is located in inlet bushing (1) and this should be checked periodically for blockage particularly if the tool slows or loses power. Remove inlet bushing (1) from motor housing (9) to clean the strainer.

Dismantling & Assembly Instructions

Disconnect tool from air supply.

With spanner wrench (31) grip the hexagon on the output spindle of random shaft assembly (28) and unscrew pad (35). Remove retaining ring (29) and grip the hexagon on the random shaft assembly (28) in a vise and gently tap the front face of eccentric hub (27) and so remove the random shaft assembly (28) from eccentric hub (27). Grip motor housing (9) in a vise fitted with soft jaws and unscrew motor lock nut (26) and pull out the complete motor/ eccentric hub assembly from motor housing (9) and note at this time how the spacer (25) locates in the groove in the front main bore of motor housing (9). Grip rear plate (16) and tap the rear end of rotor (20) to drive it through rear plate (16) and bearing (15) assembly. Tap out bearing (15) from rear plate (16). Remove cylinder (18) noting for reassembly how it locates to rear plate (16) via roll pin (17). Remove 4 rotor blades (19) from rotor (20). Carefully grip rotor (20) so as not to damage or raise burrs on it and unscrew eccentric hub (27) and take off motor lock nut (26). Tap rotor (20) through spacer (25), bearing (24), shim (23), front plate (22) and collar (21). Tap out bearing (24) from front plate (22). Unscrew inlet bushing with screen (1) and take off deflector (2) and O-Ring (3). Pull out muffler (8), valve spring (4) and valve assembly comprising of valve (5) and roll pin (6). Do not remove valve seat (7) unless a replacement is required. Tap out pin (10) and pull out trigger assembly comprising of trigger (12) and valve shaft (11). Trigger (12) may be pried off valve shaft (11). From the rear end of motor housing (9) push out regulator (14) and O-Ring (13).

Reassembly

Clean all parts and examine for wear and replace any parts with parts obtained from the manufacturer or an authorized distributor and assemble in the reverse order. On completing assembly, with trigger (12) depressed, pour into inlet bushing (1) 5ml of a suitable pneumatic tool lubricating oil. Release trigger and connect to a suitable air supply and run the tool slowly for 2 to 3 seconds to allow oil to circulate.



5201 Micro D/A Sander

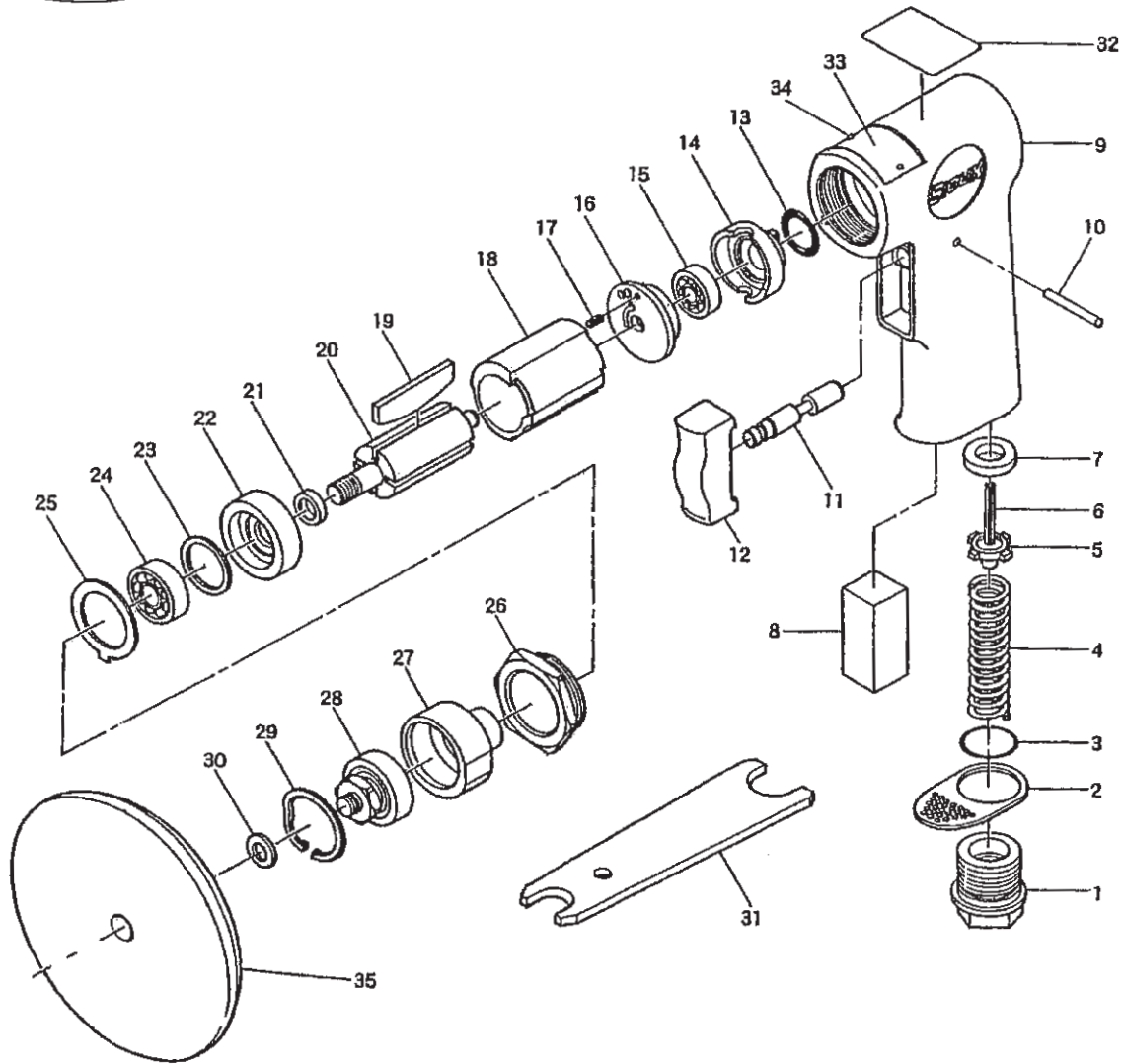

Ref. No.	Part No.	Description
1	505372	Inlet Bushing w/Screen
2	505709	Deflector
3	505371	O-Ring
4	505710	Valve Spring
5	505367	Valve
6	505366	Roll Pin
7	505365	Valve Seat
8	505711	Muffler
9	505712	Motor Housing
10	505713	Reverse Valve Pin
11	505714	Valve Shaft
12	505715	Trigger
13	67081	O-Ring
14	505716	Regulator
15	66504	Ball Bearing
16	505717	Rear Plate
17	66502	Roll Pin
18	66509	Cylinder
19	66507	Rotor Blade (Set of 4)







Ref. No.	Part No.	Description
20	505718	Rotor
21	505719	Collar
22	505720	Front Plate
23	505721	Shim
24	67472	Ball Bearing
25	505722	Spacer
26	505728	Motor Lock Nut
27	505729	Eccentric Hub
28	505730	Random Shaft Assembly
29	505731	Retaining Ring
30	505732	Washer
31	505725	Spanner Wrench
32	505001	Warning Label
33	505734	Name Plate
34	67255	Name Plate Screw (2)*
35	515	3" Velcro Pad
	515 1	3" Interface Pad (Not Shown)
	515-600	3" P600 Grit Disc (Not Shown)

* Order Quantity As Needed

Operation Specification	
Air Consumption	2.5 cfm (18 scfm)
Air Inlet Thread	1/4-18NPT
Overall Length	4.37" (111 mm)
at 90 PSIG/6.2 bar	

NOTES

NOTES

Manufacturer/Supplier Sioux Tools Inc. 2901 Floyd Boulevard P.O. Box 507 Sioux City, IA 51102 U.S.A. Tel No. 712-252-0525 Fax No. 712-252-4267		Product Type Micro D/A Sander	RPM 15,000 Cycles Per Min.	
		Model No/Nos 5201	Serial No.	
Product Net Weight 1.36 lbs 0.62 Kg	Recommended Use Of Balancer Or Support NO	Recommended Hose Bore Size – Minimum 5/16 Ins 8 mm	Recommended Max. Hose Length 30 Ft 10 M	
Air Pressure Recommended Working 6.2 bar 90 PSI Maximum 6.2 bar 90 PSI		Noise Level: Sound Pressure Level 82.0 dB(A) Test Method: Tested in accordance with Pneurop test code PN8NTC1 and ISO Standard 3744		
SAFETY MESSAGES Personal Safety Equipment Use – Safety Glasses YES Use – Safety Gloves YES Use – Safety Boots Use – Breathing Masks YES Use – Ear Protectors	 WARNING  Always Read Instructions Before Using Power Tools  Always Wear Safety Goggles  Wear Hearing Protection  Avoid Prolonged Exposure To Vibration	Vibration Level 3.7 Meters / Sec²	Test Method: Tested in accordance with ISO standards 8662/1	



Declaration of Conformity
Sioux Tools Inc.
2901 Floyd Boulevard, P.O. Box 507, Sioux City, Iowa 51102
declare under our sole responsibility that the product

Model 5201 Micro D/A Sander, Serial Number
to which this declaration relates is in conformity with the following standard(s) or other normative document(s)
EN792 (Draft), EN292 Parts 1 & 2, ISO 8662 Part 1, Pneurop PN8NTC1
following the provisions of **89/392/EEC as amended by 91/368/EEC & 93/44/EEC Directives**

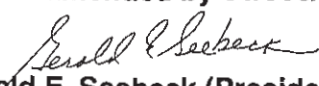
Gerald E. Seebeck (President)

Name and signature or equivalent marking of authorized person

This pdf incorporates the following model numbers:
5201