



# Model 5566

## 3/4" (20 mm) Belt Sander

Form # Z518A  
Date 5-99/B



### IMPORTANT

Read these instructions carefully before installing, operating, servicing or repairing this tool. Keep these instructions in a safe accessible place.

SAFETY MESSAGES		WARNING	Operator Instructions
Personal Safety Equipment		Always Read Instructions Before Using Power Tools	<b>Includes:</b> Safety Rules Foreseen Use Work Stations Putting into Service Operating Dismantling and Assembly.
Use – Safety Glasses	YES	Always Wear Safety Goggles	
Use – Safety Gloves		Wear Hearing Protection	
Use – Safety Boots		Avoid Prolonged Exposure To Vibration	
Use – Breathing Masks	YES		
Use – Ear Protectors			

### Safety rules when using a 5566 Belt Sander

- Always wear safety goggles.
- Do not use as a grinder.
- Use accessories rated for at least 2,000 m/min. belt speed.
- Prolonged exposure to vibration may cause injury.
- Read all instructions before using this tool. All operators must be fully trained in its use and aware of these safety rules.
- Do not exceed the maximum working air pressure.
- Use personal protection equipment as recommended.
- Use compressed air only at the recommended conditions.
- If the tool appears to malfunction, remove from use immediately and arrange for service and repair. If it is not practical to remove tool from service, then shut off the air supply to the tool and write or have written a warning note and attach it to the tool.
- If tool is to be used with a balancer or other suspension device, ensure that the tool is firmly attached to the suspension/support device.
- When operating the tool, always keep the body and particularly the hands away from the working attachment fixed to the tool.
- The tool is not electrically insulated. Never use the tool if there is any chance of coming into contact with live electricity.
- Always when using the tool, adopt a firm footing and/or position and grip the tool sufficiently only to overcome any reaction forces that may result from the tool doing work. Do not overgrip.
- Use only correct spare parts for maintenance and repair. Do not improvise or make temporary repairs. Major servicing and repairs should only be carried out by persons trained to do so.
- Do not lock, tape, wire, etc. the 'On/Off' valve in 'On' position. The throttle trigger/ lever, etc. must always be free to return to the 'Off' position when released.
- Always shut off the air supply to the tool and press the 'On/Off' valve to exhaust the air from the feed hose before fitting, removing or adjusting the working attachment fitted to the tool.
- Before using the tool, make sure that a shut off device has been fitted to the supply line and the position is known and easily accessible so that the air supply to the tool can be shut off in an emergency.
- Check hose and fittings regularly for wear.
- Take care against entanglement of the moving parts of the tool with clothing, hair, ties, cleaning rags, rings, jewelry, watches, bracelets, etc. This could cause the body or parts of the body to be drawn towards and in contact with the moving parts of the tool and could be very dangerous.
- It is expected that users will adopt safe working practices and observe all local, regional or country legal requirements when installing, using or maintaining the tool.
- Take care that the exhaust air does not point towards any other person or material or substance that could be contaminated by oil droplets. When first lubricating a tool or if the tool exhaust has a high oil content, do not allow the exhaust air to come near very hot surfaces or flames.
- Never lay the tool down until the working attachment has stopped moving.
- When the tool is not in use, shut off the air supply and press throttle trigger/lever to drain the supply line. If the tool is not to be used for a period of time, first lubricate, disconnect from air supply and store in a dry average room temperature environment.
- If the tool is passed from one user to a new or inexperienced user, make sure these instructions are available to be passed with the tool.
- Do not remove any manufacturer fitted safety devices where fitted, i.e., wheel guards, safety trigger, speed governors, etc.

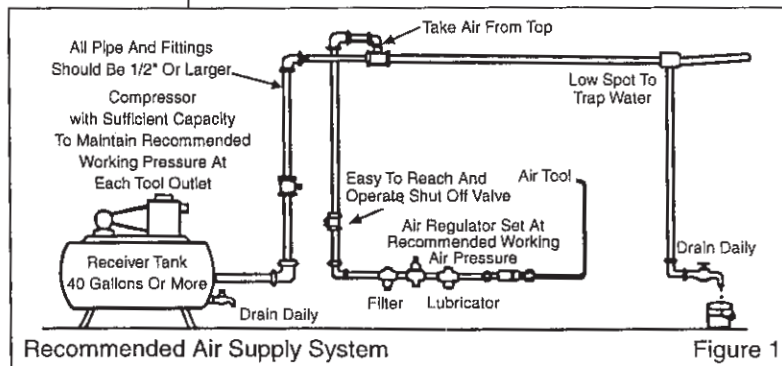

- Wherever possible, secure workpiece with clamps, a vise, etc. to make it rigid so it does not move during the work operation. Keep good balance at all times. Do not stretch or overreach.
  - Try to match the tool to the work operation. Do not use a tool that is too light or heavy for the work operation. If in doubt, seek advice.
  - In general terms, this tool is not suitable for underwater use or use in explosive environments — seek advice from manufacturer.
- Try to make sure that the work area is clear to enable the work task to be performed safely. If practical and possible, try to clear unnecessary obstructions before starting work.
  - Always use air hose and couplings with minimum working pressure ratings at least 1 1/2 times the maximum working pressure rating of the tool.

## Foreseen Use Of The Tool – 5566

The tool is designed for the purpose of cleaning or sanding of materials using a continuous abrasive belt. Belts are available in various grades to suit fine finishing or fast material removal.

Do not use the tool for any other purpose than that for which it was designed. Do not modify the tool for any other use or for its use as a belt sander without first consulting the manufacturer or his authorized representative.

## Work Stations

The tool should only be used as a handheld, hand operated tool. It is always recommended that the tool is used when standing on a solid floor. It can be used in other positions, but before any such use, the operator must be in a secure position having a firm grip and footing and be aware of the safety rules to be obeyed when using the sander.

## Putting Into Service

### *Air Supply*

Use a clean lubricated air supply that will give a measured air pressure at the tool of 90 PSIG (6.2 bar) when the tool is running with the trigger/lever fully depressed. Use recommended hose size and length. It is recommended that the tool is connected to the air supply as shown in figure 1. Do not connect the tool to the air line system without incorporating an easy to reach and operate air shut off valve. The air supply should be lubricated. It is strongly recommended that an air filter, regulator, lubricator (FRL) is used as shown in Figure 1 as this will supply clean, lubricated air at the correct pressure to the tool. Details of such equipment can be obtained from your supplier. If such equipment is not used, then the tool should be lubricated by shutting off the air supply to the tool, depressurizing the line by pressing the trigger on the tool. Disconnect the air line and pour into the hose adaptor a teaspoonful (5ml) of a suitable pneumatic motor lubricating oil preferably incorporating a rust inhibitor. Reconnect tool to air supply and run tool slowly for a few seconds to allow air to circulate the oil. If tool is used frequently, lubricate on daily basis and if tool starts to slow or lose power.

It is recommended that the air pressure at the tool while the tool is running is 90 PSI/6.2 bar. The tool can run at lower and higher pressures with the maximum permitted working pressure of 90 PSI/6.2 bar.

## Operating

Select a suitable abrasive belt of the required grade to achieve a fine sanded finish or high metal removal. The belt size for this tool is 3/4" (20 mm) wide x 24" (610 mm) circumference (continuous belt) and is available in various grades. The lowest is grade 40 grit, which is coarse for high material removal and other grits are available, such as 40, 50, 60, 80, 100 and 120. The coarseness of the grit decreases as the grade number increases, hence 40 is coarse and 120 very fine.

To fit a belt, press down the stopper and push the idle pulley towards the tool until the stopper clicks into place, which releases the tension and holds the tension off the belt. Fit the belt ensuring that it sits centrally on the drive pulley and the idle pulley. Release the stopper to tighten the belt. Start the tool slowly and use the adjusting screw (47) to align the belt centrally.

Apply the sander lightly to the work and allow the belt to cut. Take great care when sanding around sharp edges and corners to avoid snagging, belt damage or breakage. It is always recommended to use safety glasses and a breathing mask. The sanding of certain materials may create a hazardous dust which may require special breathing equipment. Check before using the tool.

Even if the tool has a low noise level, the actual sanding process may create a noise such that hearing protectors should be worn.

If there are sharp edges on the material being sanded, then safety gloves are recommended. Do not continue to use belts that are clogged or worn as this will make the sanding process inefficient and increase the need to apply unnecessary high loads to the tool.

Only use belts of the dimensions specified. Using an incorrect belt could cause it to break or fly off. Both occurrences could be dangerous.

## Dismantling & Assembly Instructions

Disconnect tool from air supply.

Lift cover (44), press down stopper (28) to reduce tension on abrasive belt and push on idle pulley (40) to remove belt.

Remove capscrew (38) and washer (37) to remove shoe (32). Take out 2 screws (38) and 2 washers (37) to remove fingerplate (39). Tap out idle shaft screw (42) to release idle pulley assembly (40). The idle pulley assembly may be dismantled by tapping out the bearings from idle pulley releasing collar.

Drive out pin (45) to remove wheel cover lid (44). Take out 2 capscrews (33) to release cover latch (46). Pull out apron (27). Belt alignment countersunk screw may be removed from tension arm (36) if a replacement is required.

Drive out stop pin (36) and pull out tension arm (35) and spring (34). Drive out pin (30) and take off stopper (28) and stopper spring (29). Insert rod in hole of drive pulley (22) to prevent rotation and unscrew nut (24) with washer (23). Take off drive pulley (22). Note how drive pulley (22) locates on pin (19) in rotor (17).

Unscrew capscrew (31) to remove wheel cover (26). Unscrew air inlet (11) from motor housing (1) and take off deflector (10). Drive out pin (9) and remove lever (8). Unscrew valve body (7) and take out O-rings (6) and (5), valve stem (4) with O-ring (3) and spring (2).



# 5566 3/4" (20 mm) Belt Sander

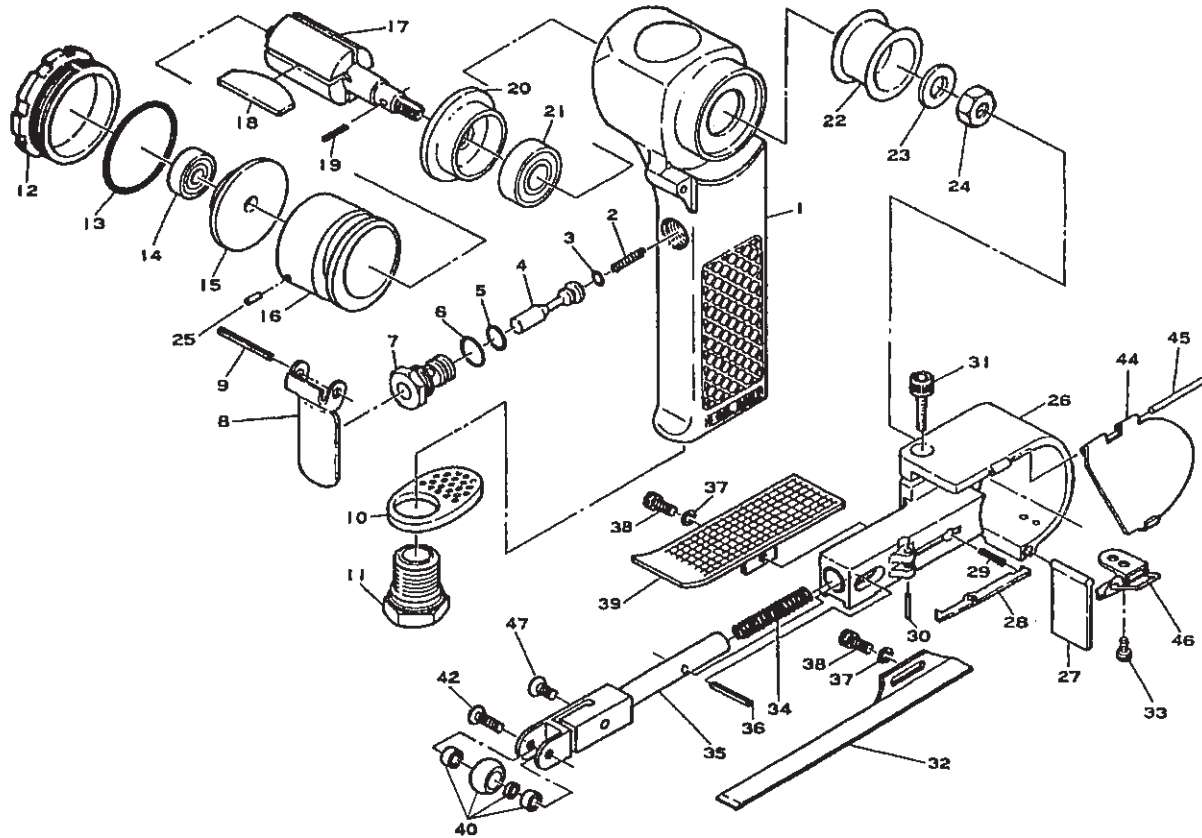

Ref. No.	Part No.	Description
1	67313	Motor Housing
2	67314	Spring
3	67077	O-Ring
4	67315	Valve Stem
5	66600	O-Ring
6	67412	O-Ring
7	67316	Valve Body
8	67317	Throttle Lever
9	66540	Lever Pin
10	67318	Deflector
11	67319	Air Inlet
12	67320	Motor Nut
13	67321	O-Ring
14	66504	Ball Bearing
15	67622	Rear Plate
16	67323	Cylinder
17	67324	Rotor
18	67325	Rotor Blade (Set of 4)
19	67326	Roll Pin
20	67327	Front Plate
21	67328	Ball Bearing
22	505586	Drive Pulley
23	67330	Washer
24	67331	Lock Nut

Ref. No.	Part No.	Description
25	67332	Cylinder Pin
26	505587	Wheel Cover
27	67334	Apron
28	67335	Stopper
29	67336	Stopper Spring
30	67337	Roll Pin
31	67338	Cap Screw
32	67339	Shoe
33	67340	Cap Screw (2)*
34	67341	Tension Spring
35	67342	Tension Arm
36	67343	Stopper Pin
37	67344	Washer (2)*
38	67345	Cap Screw (2)*
39	67346	Finger Plate
40	505583	Idle Pulley Assembly
42	67349	Idle Shaft Screw
44	67351	Wheel Cover Lid
45	67352	Roll Pin
46	67353	Cover Latch
47	67354	Adjusting Screw
Not Shown	67379	Allen Wrench
Not Shown	505588	Name Plate
Not Shown	67391	Warning Label

\*Order Quantity as Needed







Unscrew motor nut (12) from motor housing (1) with O-ring (13). Tap rotor (17) carefully (so as not to damage thread) to remove the motor assembly from motor housing (1). Pin (19) can be taken out of rotor (17). Note how the pin (25) in cylinder (16) locates the motor assembly in the groove in motor housing (1) and that the pin (25) is at the rear end plate (15) end. Hold motor assembly and again tap the threaded end of the rotor (17) to drive it through the front end plate (20) and bearing (21) assembly. Tap out bearing (21) from front end plate (20). Take off cylinder (16) and 4 rotor blades (18). Support the rear end plate (15) with a piece of tube just slightly larger than the maximum diameter of the rotor and tap the non-threaded end of the rotor (17) through the rear end plate assembly. Tap out bearing (14) from rear end plate (15).

### Reassembly

Clean all parts and examine for wear, particularly O-rings, bearings and rotor blades. Use only manufacturer or authorized distributor supplied spare parts. Pack all bearings with a general purpose grease and reassemble in the reverse order. Refit belt and adjust alignment using screw (47).

Operation Specification	
Average Air Consumption	2.8 cfm (20 scfm)
Air Inlet Thread	1/4-18NPT
Length	16.6" (422 mm)
Width	3.9" (100 mm)
at 90 PSIG/6.2 bar	

NOTES

<b>Manufacturer/Supplier</b> <b>Sioux Tools Inc.</b> <b>2901 Floyd Boulevard</b> <b>P.O. Box 507</b> <b>Sioux City, IA 51102</b> <b>U.S.A.</b> <b>Tel No. 712-252-0525 Fax No. 712-252-4267</b>		<b>Product Type</b> <b>3/4" (20 mm) Belt Sander</b>	<b>Belt Speed</b> <b>1,900</b> <small>M/Min.</small>	
<b>Model No/Nos</b> <b>5566</b>		<b>Serial No.</b>		
<b>Product Net Weight</b> 3.04 lbs 1.38 Kg	<b>Recommended Use Of</b> <b>Balancer Or Support</b> <b>NO</b>	<b>Recommended Hose Bore</b> <b>Size – Minimum</b> <b>3/8 Ins 10 mm</b>	<b>Recommended Max.</b> <b>Hose Length</b> <b>30 Ft 10 M</b>	
<b>Air Pressure</b> <b>Recommended Working</b> 6.2 bar 90 PSI <b>Maximum</b> 6.2 bar 90 PSI		<b>Noise Level: Sound Pressure Level 87.0 dB(A)</b> <b>Sound Power Level 98.0 dB(A)</b> <b>Test Method: Tested in accordance with Pneurop test code PN8NTC1 and ISO Standard 3744</b>		
<b>SAFETY MESSAGES</b> <b>Personal Safety Equipment</b> Use – Safety Glasses <b>YES</b> Use – Safety Gloves Use – Safety Boots Use – Breathing Masks <b>YES</b> Use – Ear Protectors	 <b>WARNING</b>  Always Read Instructions Before Using Power Tools  Always Wear Safety Goggles  Wear Hearing Protection  Avoid Prolonged Exposure To Vibration	<b>Vibration Level</b> <b>Less than 2.5 Meters / Sec<sup>2</sup></b> <b>Test Method: Tested in accordance with ISO standards 8662/1</b>		



**Declaration of Conformity**  
**Sioux Tools Inc.**  
**2901 Floyd Boulevard, P.O. Box 507, Sioux City, Iowa 51102**  
declare under our sole responsibility that the product

**Model 5566 Belt Sander, Serial Number**  
to which this declaration relates is in conformity with the following standard(s) or other normative document(s)  
**EN792 (Draft), EN292 Parts 1 & 2, ISO 8662 Part 1, Pneurop PN8NTC1**  
following the provisions of **89/392/EEC as amended by 91/368/EEC & 93/44/EEC Directives**

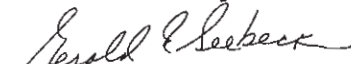
  
**Gerald E. Seebeck (President)**

Name and signature or equivalent marking of authorized person